

ENVIRO-TEC[®]
ENGINEERING FOR EXCELLENCE

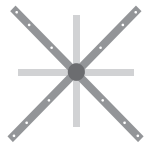

FAN POWERED VAV TERMINALS

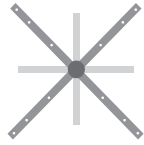
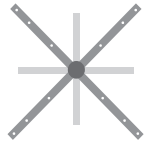
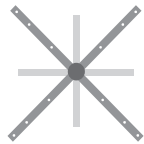

Models VFR, CFR and CFRQ

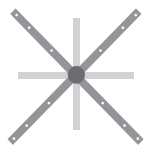
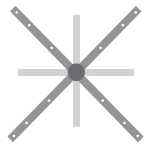

INSTALLATION, OPERATION AND MAINTENANCE MANUAL

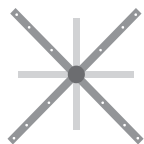

All data herein is subject to change without notice.
Refer to www.enviro-tec.com for current catalog data and
submittal drawings.

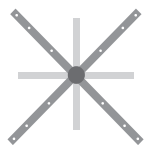

IOM-FANPOWERED

February, 2004

©2004 Environmental Technologies

Largo, FL • Part No. PX-00-0031

SAFETY CONSIDERATIONS

The equipment covered by this manual is designed for safe and reliable operation when installed and operated within its design specification limits. To avoid personal injury or damage to equipment or property while installing or operating this equipment, it is essential that qualified, experienced personnel perform these functions using good judgement and safe practices. See the following cautionary statements.

DANGER

ELECTRICAL SHOCK HAZARDS. All power must be disconnected prior to installation and servicing this equipment. More than one source of power may be present. Disconnect all power sources to avoid electrocution or shock injuries.

MOVING PARTS HAZARDS. Motor and Blower must be disconnected prior to opening access panels. Motors can start automatically, disconnect all power and control circuits prior to servicing to avoid serious crushing or dismemberment injuries.

HOT PARTS HAZARD. Electric Resistance heating elements must be disconnected prior to servicing. Electric Heaters may start automatically, disconnect all power and control circuits prior to servicing to avoid burns.

WARNING

Check that the unit assembly and component weights can be safely supported by rigging and lifting equipment.

All assemblies must be adequately secured during lifting and rigging by temporary supports and restraints until equipment is permanently fastened and set in its final location.

All unit temporary and permanent supports must be capable of safely supporting the equipment's weight and any additional live or dead loads that may be encountered. All supports must be designed to meet applicable local codes and ordinances.

All fastening devices must be designed to mechanically lock the assembly in place without the capability of loosening or breaking away due to system operation and vibration.

CAUTION

Secure all dampers when servicing damper, actuator or linkages. Dampers may activate automatically, disconnect control circuits or pneumatic control systems to avoid injury.

Protect adjacent flammable materials when brazing, Use flame and heat protection barriers where needed. Have fire extinguisher available and ready for immediate use.

NOTE: In conjunction with the use of this manual, obtain and refer to the construction, fan performance, and control wiring drawings submitted for the specific project.

PRE START-UP

WARNING: Improper installation, adjustment, alterations, service or maintenance can cause injury and property damage, as well as possible voiding of factory warranty. For assistance or additional information, consult a qualified contractor or an ENVIRO-TEC® representative.

RECEIVING AND INSPECTING

- Thoroughly examine the exterior and interior of all units for transportation damage to the cabinet, blower(s), motor(s), coil, electric heat and electrical components. Interior damage may occur without visible exterior damage. If damage is found, immediately file a claim with the carrier. Note the damage on the bill of lading before signing for the shipment.
- Check the bill of lading to verify receipt of indicated items (including loose items). Notify the local ENVIRO-TEC® representative of any shortages or items shipped in error.
- Store units in a clean, dry location, stacking no more than four high, unless utilizing original packing.

INSTALLATION

UNIT PLACEMENT AND INSTALLATION

- Before installation, remove fan packing (if provided) and foreign material from the unit interior. Check the blower wheel for free rotation.
- Do not handle the unit using coil stubouts, controls, FlowStar™ probe, or damper shaft, as damage may occur.
- The installation must conform with local building codes and the NATIONAL ELECTRIC CODE.
- Locate unit in accordance with project plans.
- Avoid unit contact with rigid objects such as conduit, sprinkler piping, and support rods.
- Fan powered unit location should follow SMACNA guidelines with respect to proximity to downstream transitions, take-offs, elbows, and tees.
- Fan powered terminals should never be installed over small occupied spaces where the wall partitions extend from slab-to-slab (i.e. fire walls or privacy walls).
- Suspend unit from building structure in a horizontal plane adhering to unit orientation labels. Use the support method shown on project plans. ENVIRO-TEC® fan powered terminals are equipped with sufficient internal vibration dampening means to prevent the need for external vibration isolation. When utilizing sheet metal straps, up to 1" long screws may be utilized to penetrate the main casing. Do not secure hanging straps to unit appurtenances such as (but not limited to) electric heater cabinets, hot water coils, and control enclosures. Unit may be equipped with optional hanging brackets. Rods up to 3/8" diameter may be utilized. Four brackets are typically provided near the unit corners. Hanger rod locations are approximately 1 1/2" to 3" from the corner of the unit for most terminal configurations. Contact the local ENVIRO-TEC® representative if precise bracket locations are required.
- Do not obstruct the access panels with support channels or straps.

CLEARANCE REQUIREMENTS

- Unit, including electric heat option, is ETL listed for 0" clearance to combustibles.
- Unit requires sufficient clearance to service the fan assembly and to access all electrical and control enclosures, as indicated on the submittal drawing. Bottom casing access panel requires sufficient clearance to access fasteners, and to lower and slide panel horizontally until clear of bottom of unit. Unit equipped with optional filter requires sufficient access to replace filter.

- Unit should not make contact with the structure above. Model VFR units equipped with the optional induction sound baffle require a minimum of 5" between the top of the unit and the structure above.
- Line voltage and low voltage electrical enclosures must have adequate service and working clearances to meet requirements of NFPA 70 (NEC) or approval by the authority having jurisdiction.
- Additional clearance requirements may be required by local codes and are the responsibility of the installing contractor.

DUCT CONNECTIONS

Connecting duct should be configured and installed in accordance with SMACNA guidelines and local code requirements.

OUTLET

- Flexible connectors at the unit outlet are not recommended. The sagging membrane of these fittings can cause turbulence and higher air velocities that generate noise. The lightweight material allows noise to break-out, which can increase sound levels in the space below.
- Fasten and seal downstream duct in accordance with project plans. Outlet construction varies with type of heat as shown on the submittal drawing. Units with discharge mounted electric heaters accept a flanged duct connection on all four sides. The end of the heater control cabinet serves as a receiving flange. Sheet metal screws no longer than 1/2" may be utilized. For screw penetrations into control enclosure, care must be exercised to avoid damaging wire or electrical components.

INLET

- Inlet duct should be the same nominal size as unit inlet. Straight duct will yield the best airflow and acoustical performance. Flexible duct should not be utilized if critically sensitive acoustical performance is required in the space directly below the unit.
- Slide duct over inlet collar and fasten and seal in accordance with the project plans.

ELECTRICAL CONNECTIONS

Observe unit label electrical requirements before connecting power to the terminal. Electrical wiring must comply with the current revision of the National Electric Code and local codes. All disconnect switches must be in the OFF position while making electrical power connections. More than one disconnect may be provided; use tag-out/lock-out procedures. Unless otherwise specified, unit is suitable for a single point electrical connection utilizing copper conductors only. Disconnect switches are optional factory components. Refer to the wiring diagram(s) located within the electrical enclosure(s) for additional information.

The single-phase fan motor is connected to L1 unless otherwise specified. For three phase systems, the electrical contractor should alternate incoming service to help balance the electrical load. Unless otherwise specified, three phase systems require a fourth (neutral) conductor as shown on the wiring diagram. Field installed electrical components must be mounted and wired per factory supplied wiring diagram. Factory wiring must not be altered without written approval; violation of this will void the warranty. Power source must be within 10% of nameplate voltage for safe, reliable operation. If incoming voltage is 10% above or below nameplate voltage, contact power company to correct before operating terminal.

HYDRONIC CONNECTIONS (Optional)

Hot water or steam heating coils require male sweat connection. Refer to unit construction submittal drawing for specific connection size. Use appropriate brazing alloy for connection; BCuP-6 or equivalent is acceptable. Do not use soft solder. System water operating pressure must not exceed 300 PSIG.

OPERATION

START-UP

Verify internal fan packing (if provided) is removed. Verify all electrical wire terminations are secure prior energizing terminal. Plenum inlet air filter (if provided) should be installed prior to unit start-up.

Unit fan should NOT be energized without sufficient downstream resistance as indicated on the specific fan performance curve. This is typically 0.1 or 0.2 inches w.g. static pressure. Units with electric heat require a minimum of 0.1" w.g. pressure unless the specific fan curve indicates a higher value.

For temporary heat, a field fabricated perforated baffle can be utilized to obtain the necessary resistance. Manual electronic (SCR) fan speed controller (if provided) should not be adjusted downward unless the specified downstream duct is installed and airflow capacity is verified to be within the specified range for the unit size.

Prior to start-up, the project specific control sequence / wiring diagram should be obtained and understood. If factory supplied analog or DDC controls are utilized, refer to the applicable Operational Manual for start-up and balancing instructions. If consignment DDC controls are supplied, contact the project control contractor for specific start-up and balancing information.

Unit fan must not be balanced to a capacity below that shown on the applicable fan performance curve. Otherwise, the motor will not be lubricated properly, causing premature failure and voiding of the warranty.

Units with electric heat require the fan capacity to have at least 70 CFM per kW.

AIR BALANCE

Unit should not be balanced until the incoming power supply is at the permanent voltage condition. Unless otherwise specified, the fan motor has three speeds. Fan speed is selected by placement of a jumper wire on a terminal strip located within the electrical enclosure. A three position rotary switch is an optional component. Units supplied with an electronic (SCR) fan speed controller can be adjusted using a small (1/8") flat blade screwdriver.

PARALLEL FAN POWERED TERMINALS — MODEL VFR

Referring to the controller instructions, balance the primary air valve to the specified maximum and minimum airflow capacity with the unit fan deenergized. Calibrate the unit fan to be energized at the specified primary airflow capacity or space temperature setpoint. Set unit to the full heating condition — primary air valve should be at the minimum airflow capacity and the unit fan should be on. Measuring airflow capacity downstream of unit, adjust fan capacity until the total airflow equals the sum of the minimum primary airflow capacity and the unit fan capacity.

Unit fan is shipped for low speed operation to optimize energy efficiency. Fan capacity should be initially verified with the fan discharge damper stop fully open and the optional electronic (SCR) controller potentiometer adjusted fully clockwise. If additional capacity is required, the fan motor can be selected to medium or high speed by moving the jumper wire located within the electrical enclosure. Fan capacity is balanced by adjusting the downstream damper stop adjustment or electronic (SCR) controller (if provided) counterclockwise. Final fan balance should occur after the motor has been running for fifteen minutes. Incoming voltage should be recorded at time of air balance.

SERIES FAN POWERED TERMINALS — MODEL CFR AND CFRQ

Referring to the controller instructions, command the primary air valve to close fully with the fan deenergized. Adjust the electronic (SCR) fan speed controller (if provided) fully clockwise. After the air valve is completely closed, energize the unit fan. Balance the primary air valve to the specified maximum and minimum airflow capacity. Set the unit to the full cooling condition (maximum primary airflow).

Adjust the unit fan to the specified capacity. If specified fan capacity is higher than maximum primary air capacity, the fan can be effectively balanced by measuring airflow downstream of unit.

If the specified fan capacity is equal to the maximum primary air capacity, the fan can be effectively balanced by observing the plenum air inlet, obtaining a neutral flow condition. If deemed easier, the fan capacity can be balanced first by measuring capacity downstream of the unit. The maximum primary air capacity can then be balanced by obtaining a neutral flow condition at the plenum air inlet.

Unit fan is shipped for low speed operation to optimize energy efficiency. Fan capacity should be initially measured with the fan discharge damper stop fully open (Model CFR Size 04 only) or the electronic (SCR) controller potentiometer adjusted fully clockwise (all other units). If additional capacity is required, the fan motor can be selected to medium or high speed by moving the jumper wire located within the electrical enclosure. Fan capacity is balanced by adjusting the downstream damper stop adjustment (Model

CFR Size 04 only) or electronic (SCR) controller (all other units). Final fan balance should occur after the motor has been running for fifteen minutes. Incoming voltage should be recorded at time of air balance.

MAINTENANCE

- **Fan Motor:** No maintenance is required as motor is equipped with permanently lubricated bearings
- **Fan Wheel:** Periodically inspect for accumulation of dust and clean as necessary
- **Filter (Optional):** Replace filter(s) as dictated by specific project conditions
- **HWC (Optional):** Inspect hot water coil periodically and clean fins if necessary

FAN MOTOR REPLACEMENT

CAUTION: Disconnect all electrical power sources before servicing unit. More than one disconnect may be supplied; use proper tag-out/lock-out procedures.

Model VFR and VFR-EH: Access is provided through the plenum inlet opening

Model VFR-WC: Access is provide through bottom access panel

- Remove optional filter and/or induction sound baffle (Model VFR and VFR-EH only)
- Disconnect the four electrical conductors from the quick disconnect plug located at the base of the motor
- Beginning at the bottom, remove four nuts from mounting lugs securing fan housing to unit casing (be prepared to support the fan housing as the last nut is removed)
- Remove the fan assembly
- Loosen set screw that secures fan wheel to the motor shaft
- Remove three nuts that secure motor brackets to fan housing
- Disconnect two capacitor leads (Caution - verify capacitor is fully discharged prior to this step)
- Slide motor shaft out of fan wheel collar

Reverse above procedure when installing new motor

- Make sure fan wheel is centered within housing before tightening set screw
- Do not over-tighten motor bracket nuts to avoid vibration problems

Electrical components are not serviceable. Faulty components should be replaced with ENVIRO-TEC® authorized parts to avoid conflict with ETL listing.

ECM Motor Guide

1. Confirm that the connections are correct using the sequence drawing located inside the control enclosure cover (see sample motor wiring drawing on next page). Make sure that both the 5 pin and the 16 pin connectors are in place.
2. Motor Power (5 pin power connector)
 - a. 4 & 5 — line voltage
 - b. 3 — ground
 - c. 120-volt motors have a jumper between 1 & 2 on the back of the connector.
3. Check for 24 volts AC between 15 & 16 on the controller (see ETPWM controller on next page).
4. Verify that the voltage between PWM & COM is between 0- VDC and 15- VDC (depending on the speed potentiometer setting).
5. Verify that the voltage between G & COM is 15 VDC.
6. With the fan relay energized the motor should run.

Sample ECM Motor Wiring

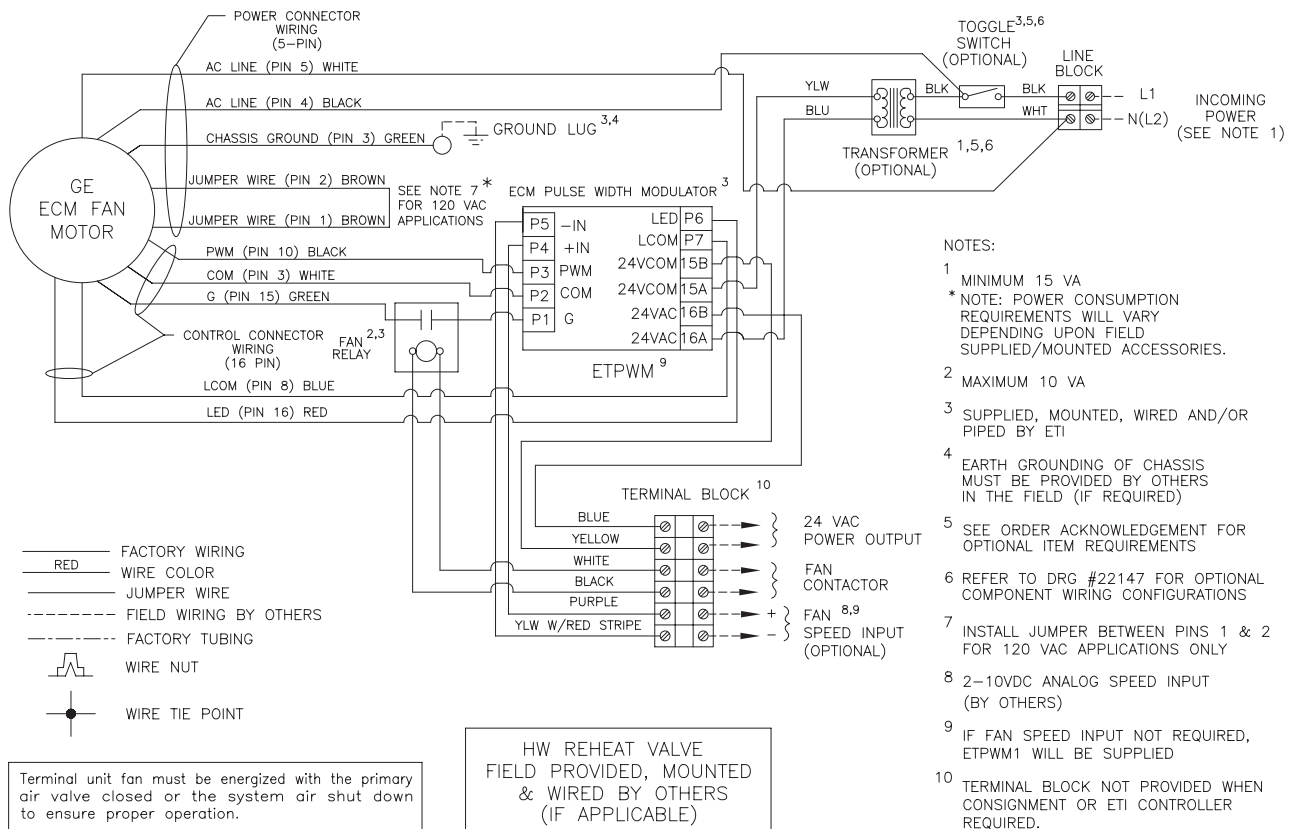

Balancing Instructions

Manual Balancing

1. Verify 22 to 28VAC between terminals 15 & 16.
2. Verify 15 VDC between G (+) & COM (-)
3. If the circuit board incorporates the optional 2-10 VDC input, plug jumper on board to “MAN”(Factory set to manual mode)
4. Connect voltmeter to VDC (+) and COM (-).
5. Determine the DC voltage for the required CFM from the drawing attached to the unit using the 5-10 VDC scale. **NOTE: Voltage limits for reliable operation are 5.10 through 9.90 VDC.**
6. Turn the slotted adjustment screw on the potentiometer labeled “SPEED” to obtain the correct voltage. Clockwise increases flow. (Scale 5-10 VDC) Use the chart on the unit being balanced.
7. Turn to the required voltage for the CFM required.

Remote Balancing

1. Determine the voltage from the axis on the unit chart labeled 2-10 VDC.
2. Plug the jumper on the board to the Remote (“REM”) position.
3. Adjust the external voltage source for the required CFM (remotely). 2-10VDC. The external voltage source must be set between 2.15 and 9.85 VDC to ensure reliable start of the motor.

ETPWM Controller

